To:	Jason Charest Chittenden County RPC	From:	Michael Fowler Stantec Consulting Services
File:	US-2 Pinch Points	Date:	August 17, 2023

Reference: Technical Feasibility Memo

INTRODUCTION

In the interest of the CCRPC and the Town of Richmond this assessment investigates the 11 identified pinch points where a 5-foot shoulder cannot be met with the existing Richmond-Bolton paving project going through this section of US-2. This high-level feasibility report will assess the pinch points by identifying the cause of the pinch point and providing an order of magnitude cost estimate to widen the roadway to achieve 5-foot shoulders in both directions of travel. Information from the ongoing Richmond-Bolton paving project will be used, and assumptions about ROW, Utilities, and permitting will be made on a site-to-site basis.

It is noted the order of magnitude cost estimates for the respective systems being examined in this report are largely based on experience and engineering judgment. Due to the uncertainty of the limited information available, it is recognized the application of a contingency factor is warranted to account for risk. Common accepted rates for these types of estimates range between 25% and 75% depending on the confidence level of the data utilized. Considering the expected reliability of the available information, a 50% contingency rate was used in the development of the cost estimates generated for this project.

Locations will be identified using the stations from the existing Richmond-Bolton paving project and will be included in Appendix A.

PINCH POINT SITE LOCATIONS

The corridor of interest is approximately 1.5 miles along US Route 2 which runs east/west in the aerial map below. US Route 2 generally parallels Interstate 89 around Richmond. Plans detailing the pinch points can be found in Appendix A.

Reference: Technical Feasibility Memo

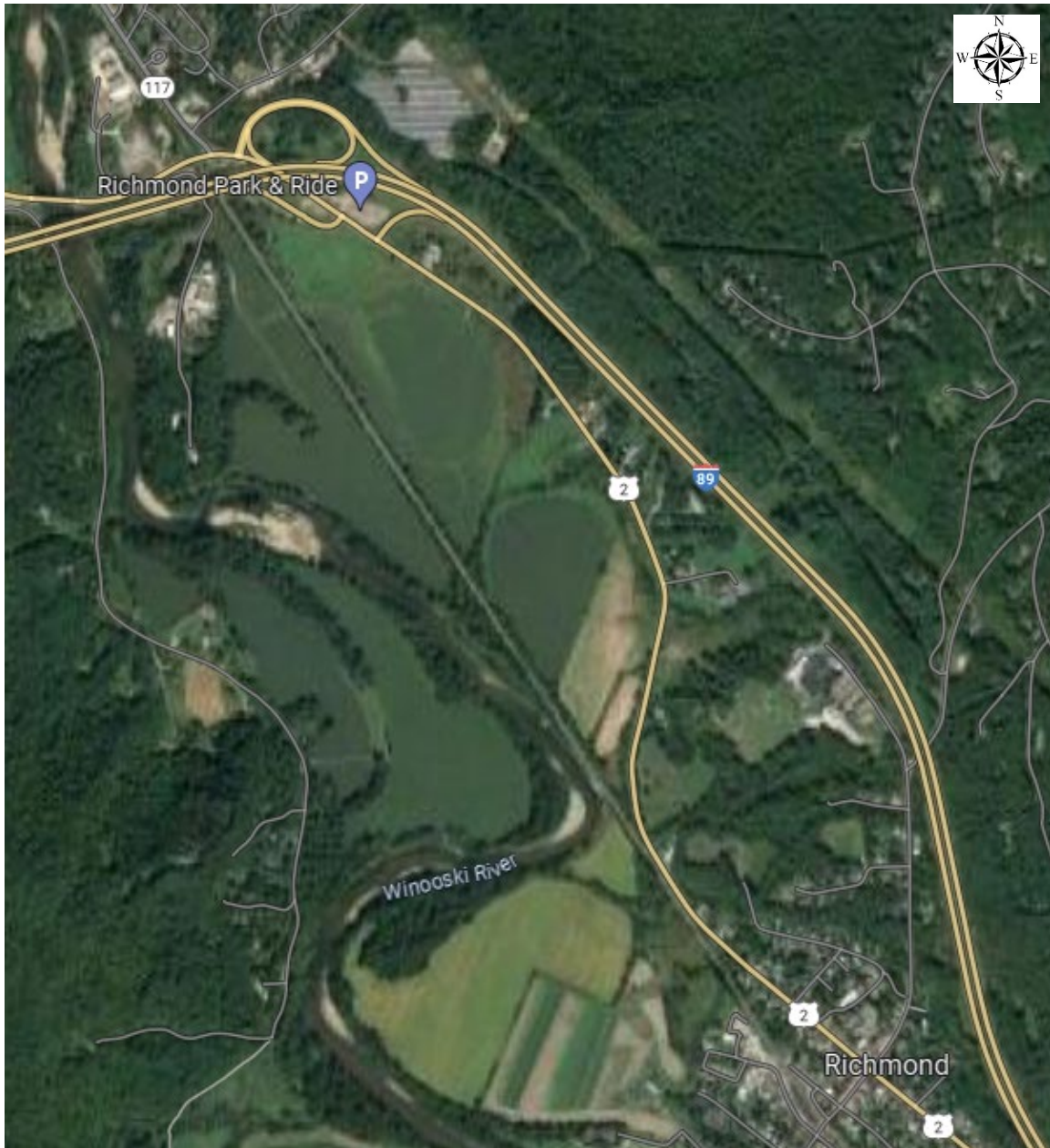

Figure 1: Google Map Snip of US-2 & Town of Richmond

Reference: Technical Feasibility Memo

LOCATION 1

Location: STA 79+20 – 81+00, LT.

Proposed Shoulder Width: LT – 3’6”

The existing retaining wall adjacent to the westbound lane is encroaching on the shoulder. Proposed solutions for the wall include relocating the wall within the state Right-of-Way (ROW), removing the wall, and adequately sloping the slope in a manner that it remains stable, or removing the vegetation that you can see in Figure 2 between the Edge of Pavement (EOP) and the start of the wall.

Assumptions:

- Limits of construction activity will remain within the existing ROW.
- Assume Categorical Exclusion (NEPA) is applicable for all work.
- No utility or historical/archeological impacts.
- Roadway impacts will be negligible.



Figure 2: Retaining wall facing east.

Order of Magnitude Estimate

Location 1	Relocate Wall	Remove & Regrade
Construction Solution	\$90,000	\$50,000
Utility Coordination	\$25,000	\$25,000
Geotechnical Analysis	\$25,000	\$5,000
Preliminary Engineering	\$75,000	\$50,000
Contingency (50%)	\$107,500	\$65,000
Approximate Total	\$322,500	\$195,000

Reference: Technical Feasibility Memo

LOCATIONS 2 & 3

Location 2 & 3: This location is planned to be addressed as part of the VTrans project Richmond STP CULV (58) Figure 3 (below) shows the projected timeline shown on VTrans's website.

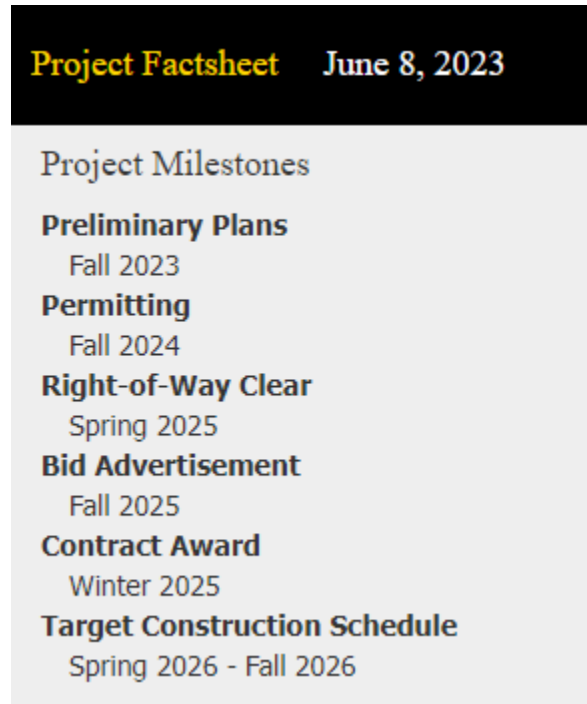

Figure 2: Schedule for STP CULV (58) Richmond

Reference: Technical Feasibility Memo

LOCATIONS 4 & 5

Location (4): STA 100+33 – 102+58, LT

Proposed Shoulder Width: LT – 4’

Location (5): STA 101+46 – 102+03, RT

Proposed Shoulder Width: RT – 1’10”

The existing bridge (#28) is showing signs of deterioration with the eastbound shoulder the narrowest of the whole stretch. Proposed solutions would include a full replacement or extending the outlet (eastbound) side of the culvert. With the extension, the realignment of US-2 could accommodate 5ft shoulders on both sides of the roadway.

While the cost estimates for these two improvements appear to be similar, the costs for rehabilitation are typically disproportionate to new construction. Rehabilitations are known to be more labor-intensive, more time-consuming, and pose more risk overall during construction. For this case, the order of magnitude difference suggests that when considering estimated service life the structure replacement solution provides the greatest benefit. In other words, the probability is high that replacement will provide at least twice as many years of service as rehabilitation.

Assumptions:

- Limits of construction activity will remain within the existing ROW.
- Assume Categorical Exclusion (NEPA) is applicable for all work.
- No utility or historical/archeological impacts.



Figure 4: Eastbound (outlet) side of culvert.

Order of Magnitude Estimate

Location 4/5	Full Replacement	Extension
Construction Solution	\$290,000	\$100,000
Utility Coordination	\$50,000	\$25,000
Geotechnical Analysis	\$50,000	\$50,000
Preliminary Engineering	\$150,000	\$100,000
Contingency (50%)	\$270,000	\$137,500
Approximate Total	\$810,000	\$412,500

Reference: Technical Feasibility Memo

LOCATIONS 6 & 7

Location (6): STA 106+18 – 107+08, LT.

Proposed Shoulder Width: LT – 2’4”

Location (7): STA 105+95 – 107+05, RT.

Proposed Shoulder Width: RT – 3’6”

The existing 2’ x 3’ box culvert (PID 64504) is too short to provide enough roadway width for the desired shoulders. Keeping VTrans maintenance personnel in mind, the best solution for this location is to replace the existing box culvert with a Pipe. Hydraulic analysis would provide a recommended pipe size.

Assumptions:

- Limits of construction activity will remain within the existing ROW.
- Assume Categorical Exclusion (NEPA) is applicable for all work.
- No utility or historical/archeological impacts.



Figure 5: Inlet side of box culvert.

Order of Magnitude Estimate

Location 6/7	Full Replacement
Construction Solution	\$325,000
Utility Coordination	\$50,000
Geotechnical Analysis	\$50,000
Preliminary Engineering	\$150,000
Contingency (50%)	\$287,500
Approximate Total	\$862,500

Reference: Technical Feasibility Memo

LOCATION 8

Location: STA 115+25 – 117+50, RT.

Proposed Shoulder Width: RT – 3’6”

With the steep fill slope behind the existing guardrail, the most appropriate and most cost-effective solution would be sheet piling. Being only 1’6” short of 5’ removing the offset blocks from the existing guardrail would allow for an additional 6”. In addition to the results of the paving project going through the corridor, if lane widths change at all the results could be very close to 5’ on the Eastbound Lane after removal of offset blocks.

Assumptions:

- Limits of construction activity will remain within the existing ROW.
- Assume Categorical Exclusion (NEPA) is applicable for all work.
- No utility or historical/archeological impacts.
- Roadway impacts will be negligible.
- Required embedment for sheet pile would be met.



Figure 6: Embankment on US-2 facing west.

Order of Magnitude Estimate

Location 8	Sheet Piling	Offset Blocks
Construction Solution	\$675,000	\$2,250
Utility Coordination	\$75,000	\$5,000
Geotechnical Analysis	\$50,000	\$0
Preliminary Engineering	\$100,000	\$5,000
Contingency (50%)	\$450,000	\$6,125
Approximate Total	\$1,350,000	\$18,375

Reference: Technical Feasibility Memo

LOCATION 9

Location: STA 120+00 – 121+03, RT.

Proposed Shoulder Width: RT – 3’7”

A combination of steep slope and proximity to the railroad limit the options to increase the shoulder along US-2. Sheet piling is the solution that would work best in this instance. The small footprint of the sheet piles could potentially stay out of the Railroad clear zone while providing extra width to the shoulder.

Assumptions:

- Limits of construction activity will remain within the existing ROW.
- Assume Categorical Exclusion (NEPA) is applicable for all work.
- No utility or historical/archeological impacts.
- Roadway impacts will be negligible.
- Required embedment for sheet pile would be met.

Order of Magnitude Estimate



Figure 7: Embankment facing eastbound along US-2.

Location 9	Sheet Piling
Construction Solution	\$309,000
Utility Coordination	\$50,000
Geotechnical Analysis	\$50,000
Preliminary Engineering	\$100,000
Contingency (50%)	\$204,500
Approximate Total	\$613,500

Reference: Technical Feasibility Memo

LOCATIONS 10 & 11

Location (10): STA 130+94 – 133+75, LT.

Proposed Shoulder Width: LT – 1’5”-3’7”

Location (11): STA 129+99 – 133+75, RT.

Proposed Shoulder Width: RT – 3’0”-4’2”

The roadway cut is narrow leaving tight shoulders on either side of US-2 coming up into the Village of Richmond. As you crest the hill heading Eastbound you are welcomed with infrastructure on both sides, including sidewalk on both sides when you reach the top of the hill. Retaining walls or sheet piling would provide adequate width to accommodate 5ft shoulders on either side. There’s a cross culvert located at STA 130+30 that will need an appropriate headwall to facilitate the wider shoulder as well.

Assumptions:

- Limits of construction activity will remain within the existing ROW.
- Assume Categorical Exclusion (NEPA) is applicable for all work.
- No utility or historical/archeological impacts.
- Roadway impacts will be negligible.
- Required embedment for sheet pile would be met.



Figure 8: Embankments along US-2 heading into Richmond Village

Order of Magnitude Estimate

Location 10/11	Sheet Piling	Retaining Wall
Construction Solution	\$1,968,000	\$656,000
Utility Coordination	\$75,000	\$75,000
Geotechnical Analysis	\$100,000	\$100,000
Preliminary Engineering	\$200,000	\$200,000
Contingency (50%)	\$1,171,500	\$515,500
Approximate Total	\$3,514,500	\$1,546,500

Reference: **Technical Feasibility Memo**

Early indications suggested sheet piling would be the most practical solution for these locations and following the site walk that notion still has merit. However, based on observations made during the site walk, it was recognized the possibility exists that a Mechanically Stabilized Earth system (MSE) may be applicable for some, if not all, of the needs for the site. Detailed design would need to be completed to validate the applicability of an MSE, but regardless it is reasonable to assume the estimated cost for the end result would be in the range of \$1.5 to \$3.5 million.

SUMMARY AND NEXT STEPS

As can be deduced from the feasibility examination of these 11 locations, there are alterations that can be made to the existing US 2 infrastructure to improve shoulder widths to the desired 5'-0" minimum. The order of magnitude cost estimates suggest the collective value of these spot treatments at approximately \$5.0 million. Securing that level of funding will require further development and refinement of scope so that actual expected costs can be better understood. Therefore, to maintain momentum the recommended next steps for the Town of Richmond are as follows:

- Work with CCRPC to submit to VPSP2 for this to become a VTrans project.
- Pursue full scoping of the locations with a geotechnical analysis to refine the cost estimates.
- Seek grant funding, as applicable.
- Town to fund and construct the projects on their own.

It is noted Steps 1 and 2 are critical path to construction and would be best expedited in sequence.

Stantec Consulting Services Inc.

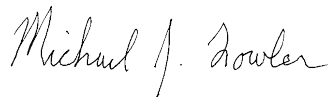

Michael Fowler, PE
Senior Transportation Engineer

Phone: 802 497 6395
michael.fowler@stantec.com

Reference: **Technical Feasibility Memo**

APPENDIX A:

Pinch Points PDF (12 Pages)

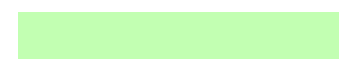
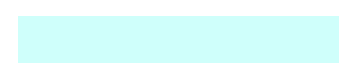

SHOULDER WIDTH COLOR KEY

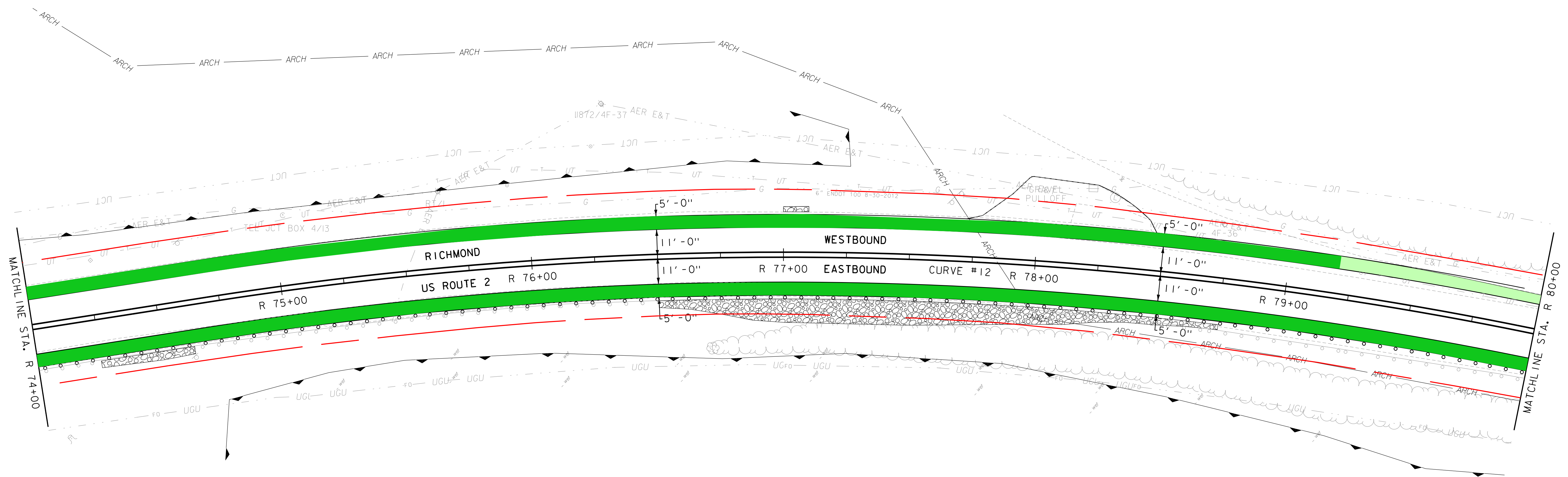
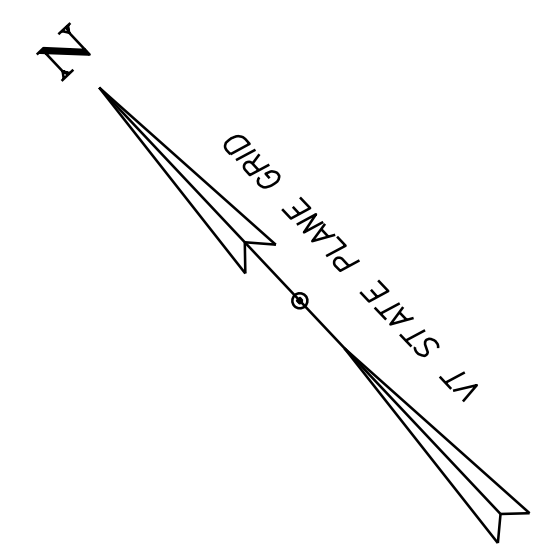
	5 FOOT OR GREATER SHOULDER WIDTH
	3 - 5 FOOT SHOULDER WIDTH
	LESS THAN 3 FOOT SHOULDER WIDTH



PROJECT NAME:	RICHMOND US-2 PINCH POINTS		
PROJECT NUMBER:	179450619		
FILE NAME:	Richmond US-2 Pinch Points.dgn	PLOT DATE:	4/20/2023
PROJECT LEADER:	M. FOWLER	DRAWN BY:	J. LAPERLE
DESIGNED BY:	J. LAPERLE	CHECKED BY:	M. FOWLER
PLAN SHEET I		SHEET	I OF 12

SHOULDER WIDTH COLOR KEY

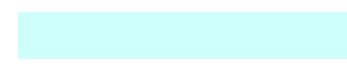

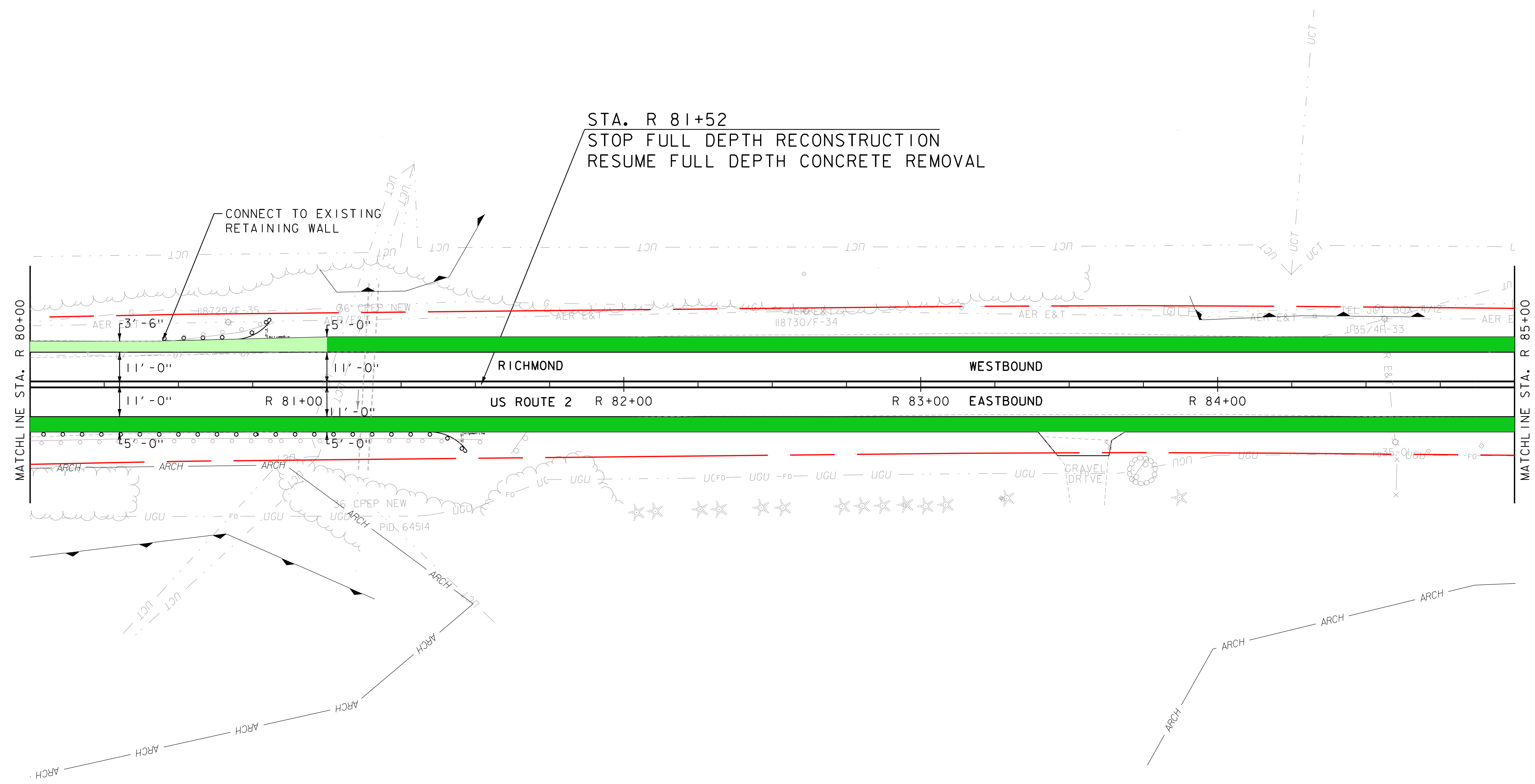
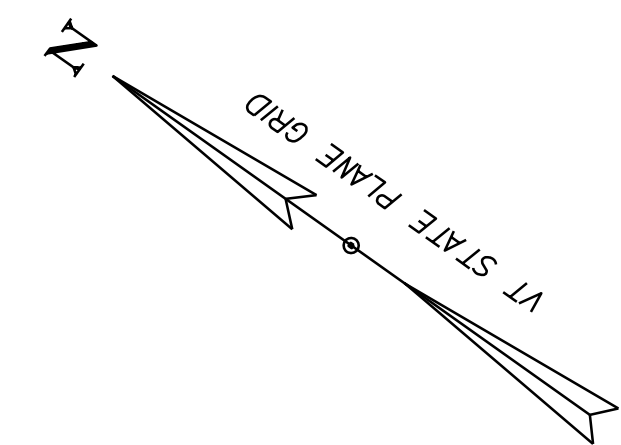
	5 FOOT OR GREATER SHOULDER WIDTH
	3 - 5 FOOT SHOULDER WIDTH
	LESS THAN 3 FOOT SHOULDER WIDTH



PROJECT NAME: RICHMOND US-2 PINCH POINTS	
PROJECT NUMBER: 179450619	
FILE NAME: Richmond US-2 Pinch Points.dgn	PLOT DATE: 4/20/2023
PROJECT LEADER: M. FOWLER	DRAWN BY: J. LAPERLE
DESIGNED BY: J. LAPERLE	CHECKED BY: M. FOWLER
PLAN SHEET 2	SHEET 2 OF 12

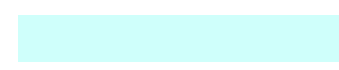

SHOULDER WIDTH COLOR KEY

	5 FOOT OR GREATER SHOULDER WIDTH
	3 - 5 FOOT SHOULDER WIDTH
	LESS THAN 3 FOOT SHOULDER WIDTH

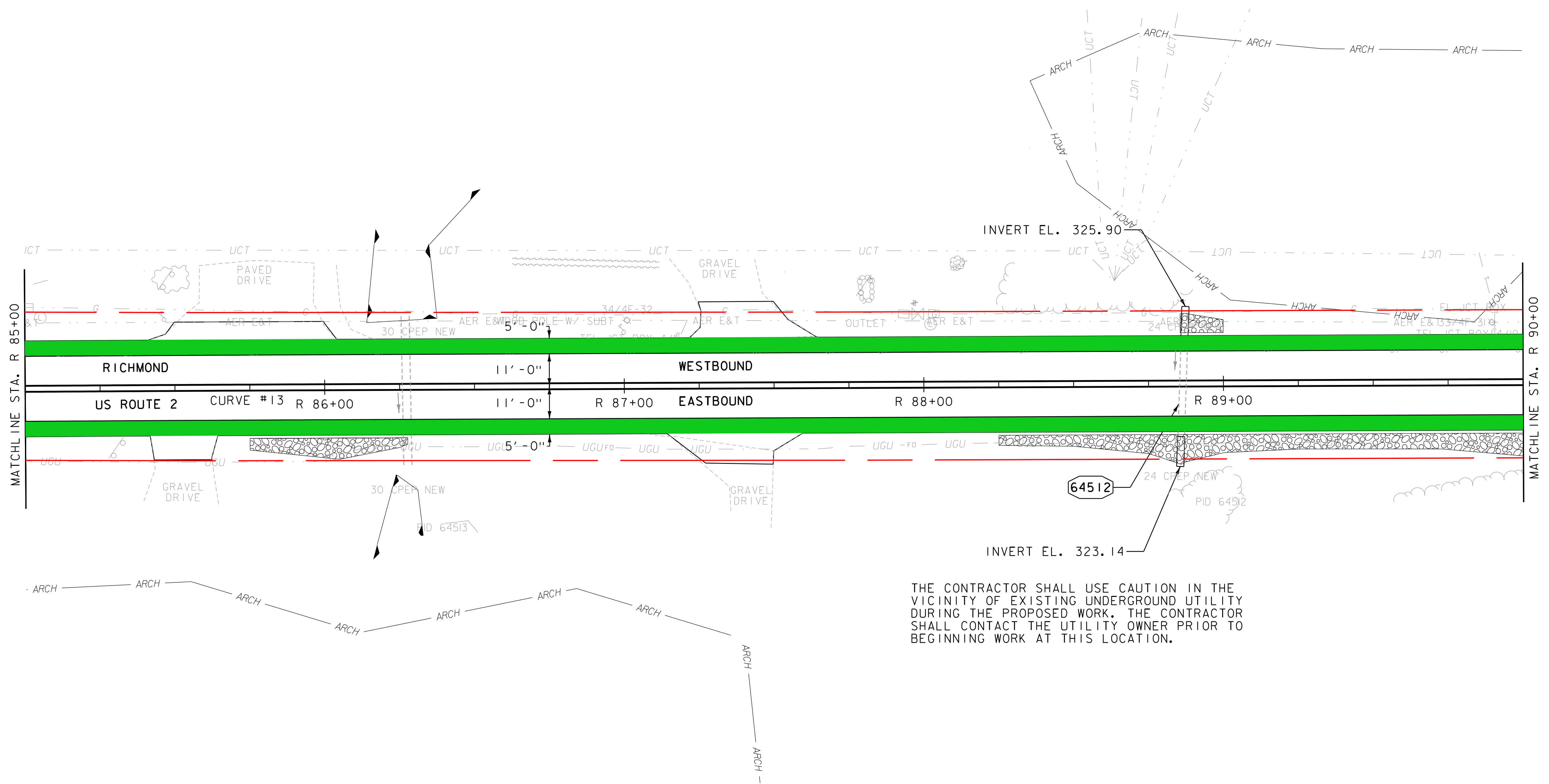
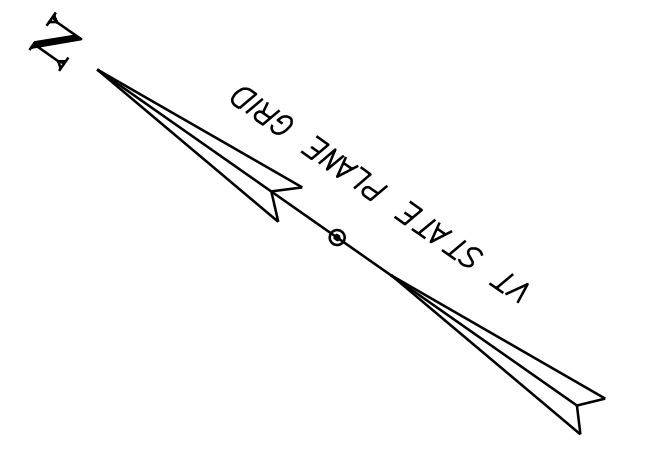



THE CONTRACTOR SHALL USE CAUTION IN THE VICINITY OF EXISTING UNDERGROUND UTILITY DURING THE PROPOSED WORK. THE CONTRACTOR SHALL CONTACT THE UTILITY OWNER PRIOR TO BEGINNING WORK AT THIS LOCATION.



PROJECT NAME:	RICHMOND US-2 PINCH POINTS
PROJECT NUMBER:	179450619
FILE NAME:	Richmond US-2 Pinch Points.dgn
PLOT DATE:	4/20/2023
PROJECT LEADER:	M. FOWLER
DRAWN BY:	J. LAPERLE
DESIGNED BY:	J. LAPERLE
CHECKED BY:	M. FOWLER
PLAN SHEET 3	SHEET 3 OF 12

SHOULDER WIDTH COLOR KEY

	5 FOOT OR GREATER SHOULDER WIDTH
	3 - 5 FOOT SHOULDER WIDTH
	LESS THAN 3 FOOT SHOULDER WIDTH

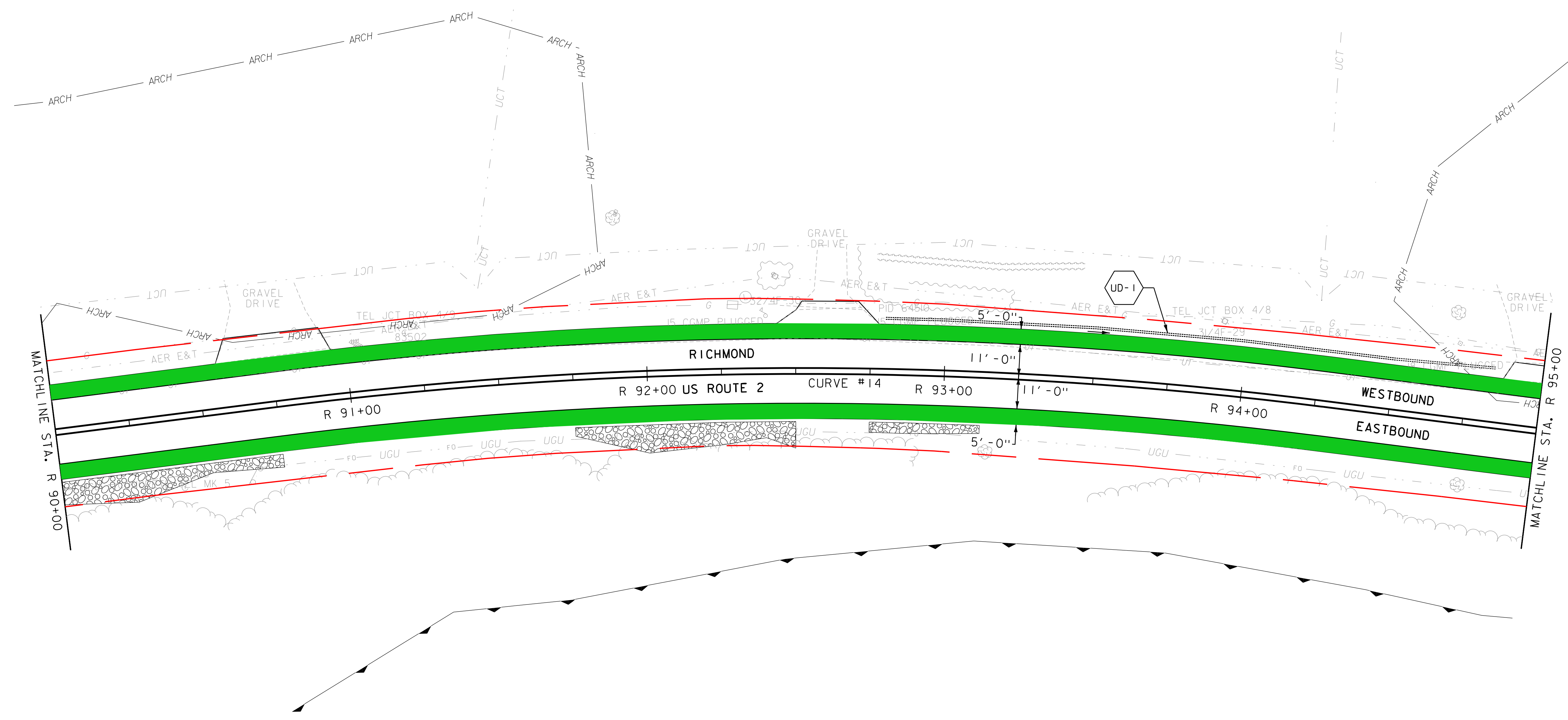
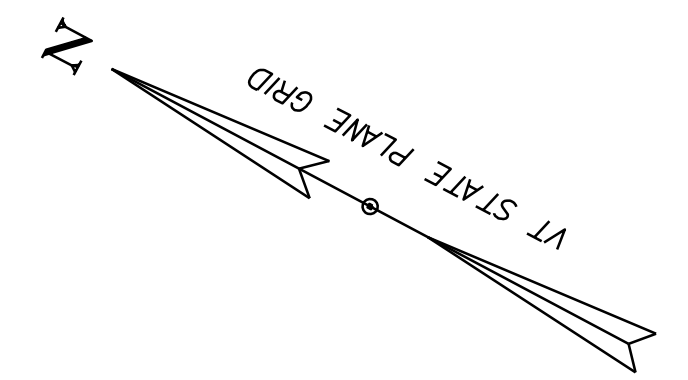

PROJECT NAME:	RICHMOND US-2 PINCH POINTS
PROJECT NUMBER:	179450619
FILE NAME:	Richmond US-2 Pinch Points.dgn
DESIGNED BY:	J. LAPERLE
PROJECT LEADER:	M. FOWLER
DRAWN BY:	J. LAPERLE
CHECKED BY:	M. FOWLER
PLAN SHEET	4 OF 12

SHOULDER WIDTH COLOR KEY

- 5 FOOT OR GREATER SHOULDER WIDTH
- 3 - 5 FOOT SHOULDER WIDTH
- LESS THAN 3 FOOT SHOULDER WIDTH

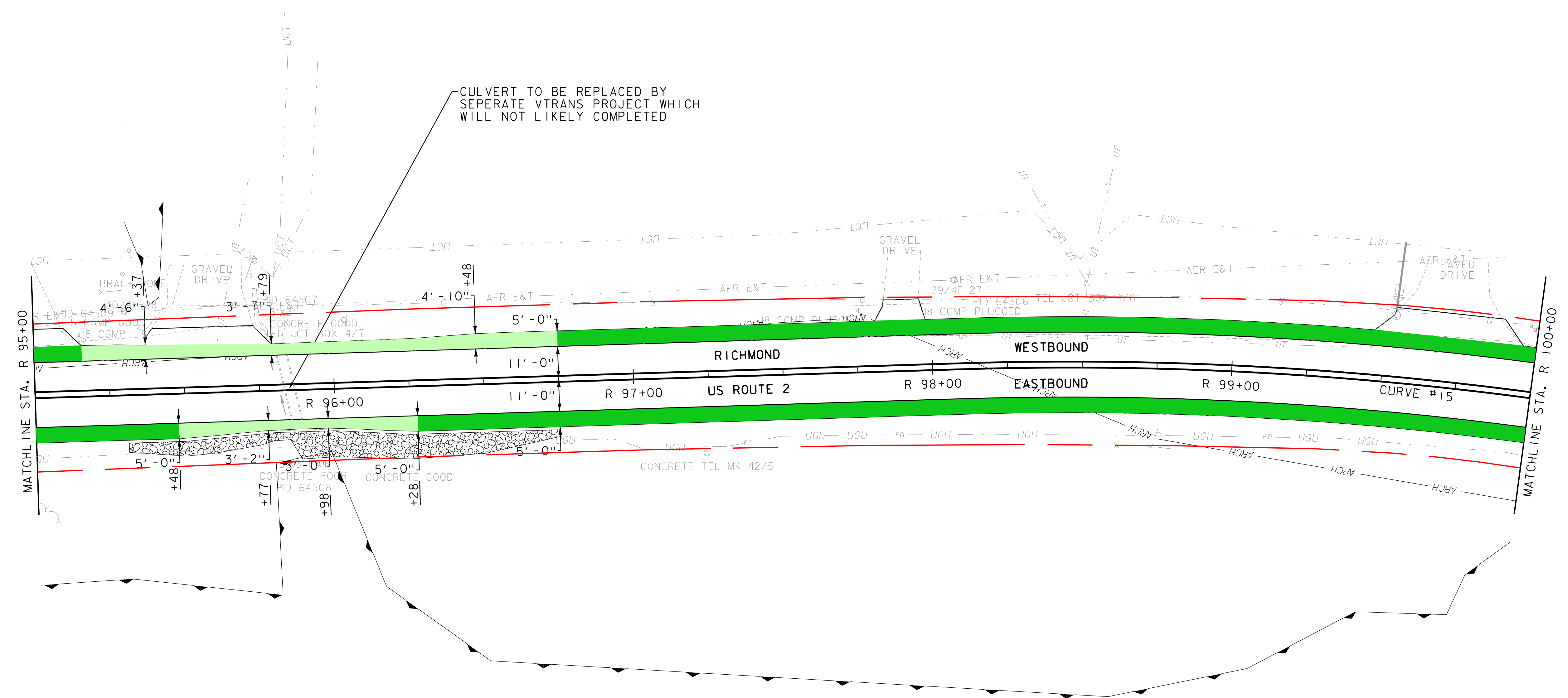
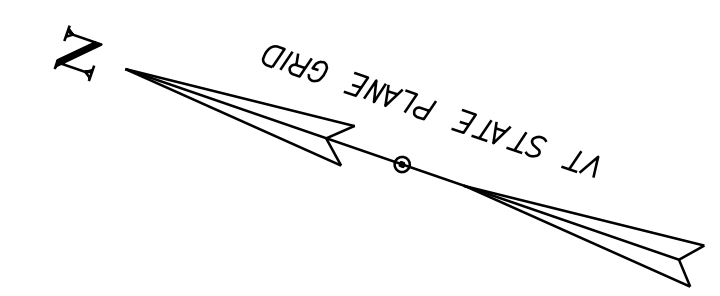

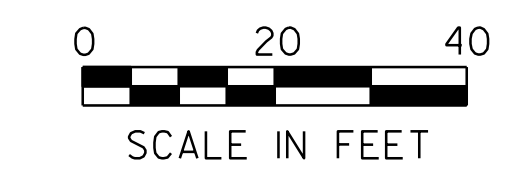

CULVERT TO BE REPLACED BY SEPERATE VTRANS PROJECT WHICH WILL NOT LIKELY COMPLETED

PROJECT NAME: RICHMOND US-2 PINCH POINTS	
PROJECT NUMBER: 179450619	
FILE NAME: Richmond US-2 Pinch Points.dgn	PLOT DATE: 4/20/2023
PROJECT LEADER: M. FOWLER	DRAWN BY: J. LAPERLE
DESIGNED BY: J. LAPERLE	CHECKED BY: M. FOWLER
PLAN SHEET 5	SHEET 5 OF 12

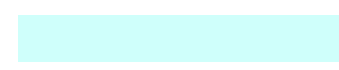

SHOULDER WIDTH COLOR KEY

	5 FOOT OR GREATER SHOULDER WIDTH
	3 - 5 FOOT SHOULDER WIDTH
	LESS THAN 3 FOOT SHOULDER WIDTH

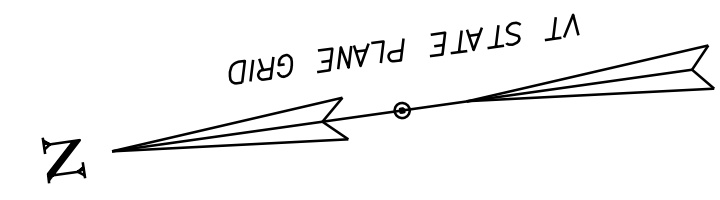

HD STEEL BEAM GUARDRAIL, GALVANIZED/NESTED
 STA. R 101+06 TO R 101+31, LT.
 SEE DETAIL OF STEEL BEAM GUARDRAIL AT SMALL
 CULVERTS ON GUARDRAIL DETAIL SHEET 1.

STA. R 102+20
 END TRANSITION FROM BRIDGE
 RESUME FULL DEPTH CONCRETE REMOVAL

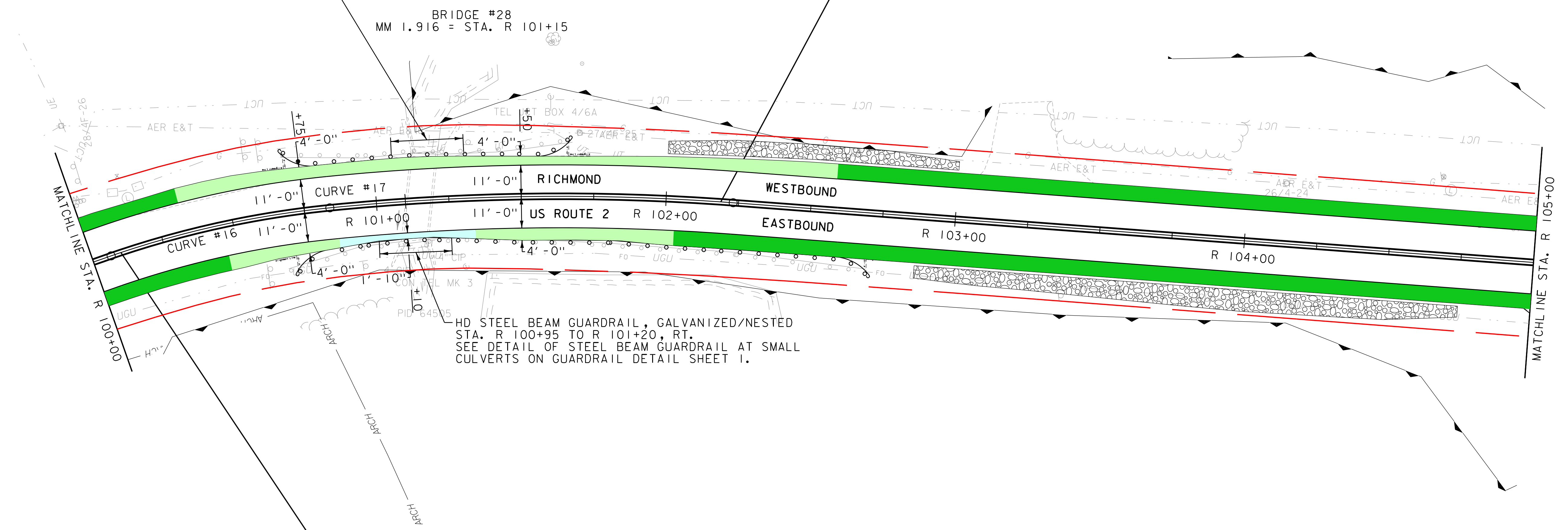



STA. R 100+10
 STOP FULL DEPTH
 CONCRETE REMOVAL
 BEGIN TRANSITION
 TO BRIDGE

HD STEEL BEAM GUARDRAIL, GALVANIZED/NESTED
 STA. R 100+95 TO R 101+20, RT.
 SEE DETAIL OF STEEL BEAM GUARDRAIL AT SMALL
 CULVERTS ON GUARDRAIL DETAIL SHEET 1.



PROJECT NAME:	RICHMOND US-2 PINCH POINTS
PROJECT NUMBER:	179450619
FILE NAME:	Richmond US-2 Pinch Points.dgn
PLOT DATE:	4/20/2023
PROJECT LEADER:	M. FOWLER
DRAWN BY:	J. LAPERLE
DESIGNED BY:	J. LAPERLE
CHECKED BY:	M. FOWLER
PLAN SHEET 6	SHEET 6 OF 12

SHOULDER WIDTH COLOR KEY

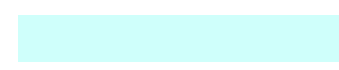

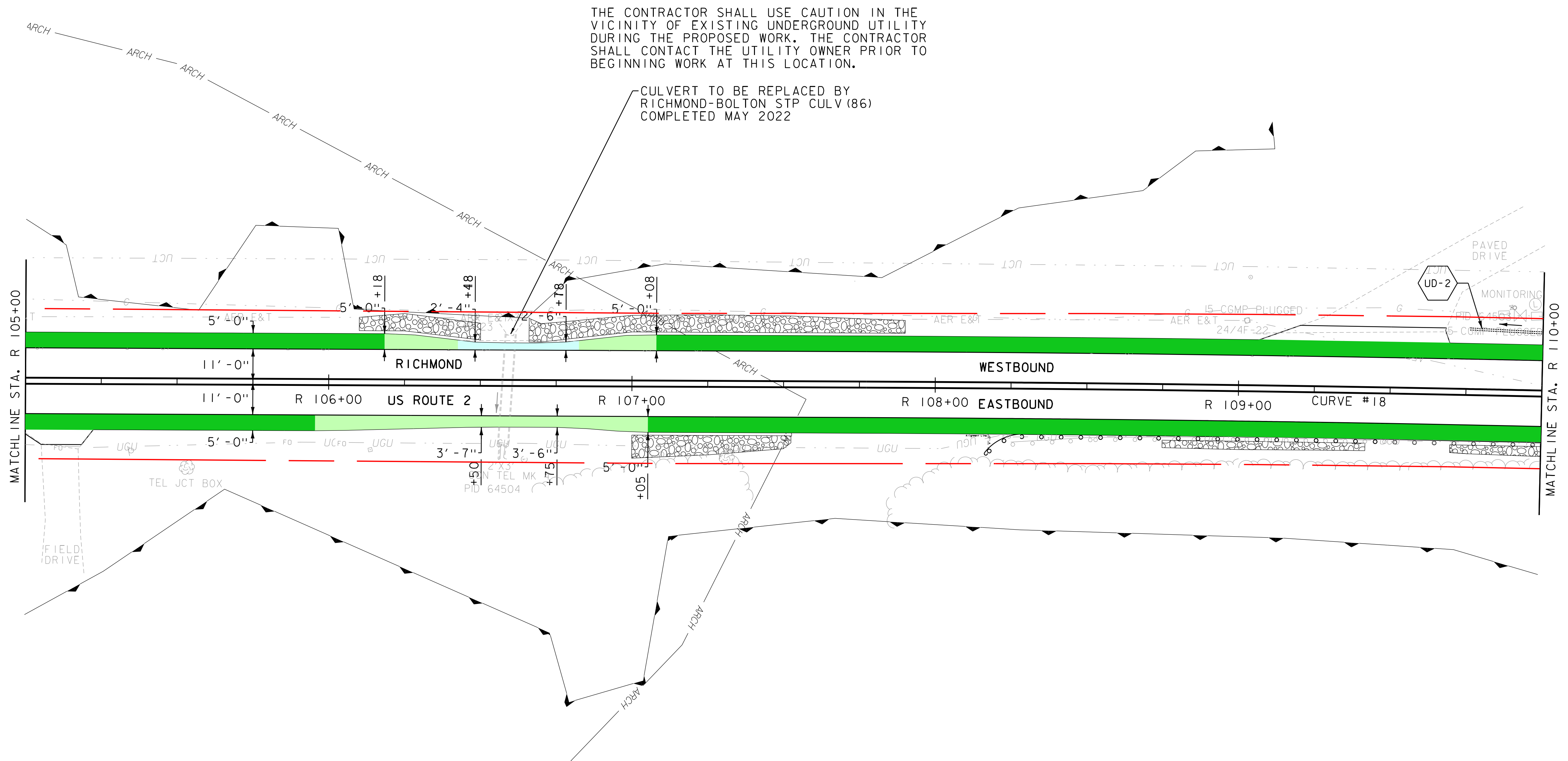
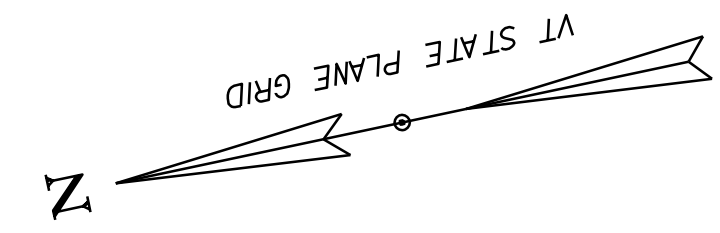
	5 FOOT OR GREATER SHOULDER WIDTH
	3 - 5 FOOT SHOULDER WIDTH
	LESS THAN 3 FOOT SHOULDER WIDTH

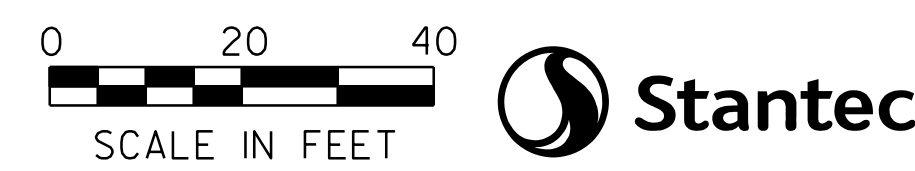

PROJECT NAME: RICHMOND US-2 PINCH POINTS
 PROJECT NUMBER: 179450619
 FILE NAME: Richmond US-2 Pinch Points.dgn PLOT DATE: 4/20/2023
 PROJECT LEADER: M. FOWLER DRAWN BY: J. LAPERLE
 DESIGNED BY: J. LAPERLE CHECKED BY: M. FOWLER
 PLAN SHEET 7 SHEET 7 OF 12



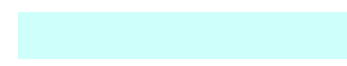

SHOULDER WIDTH COLOR KEY

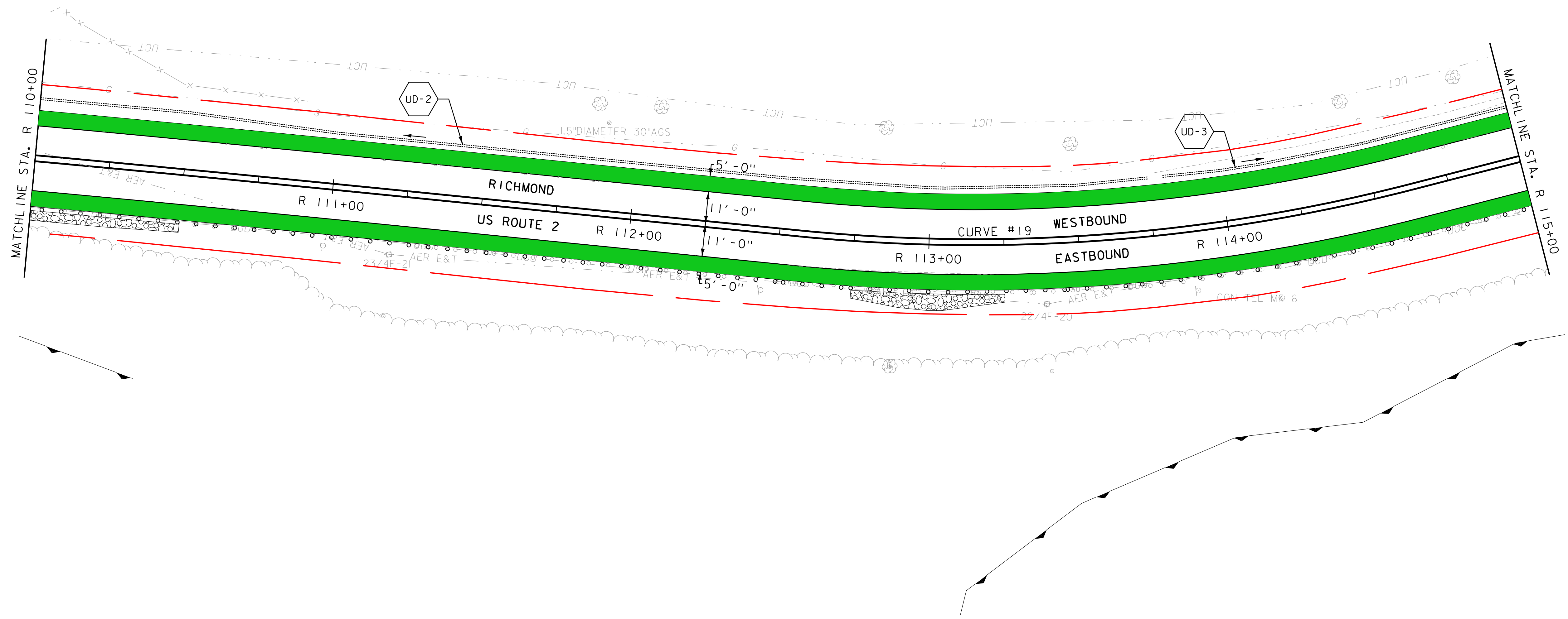
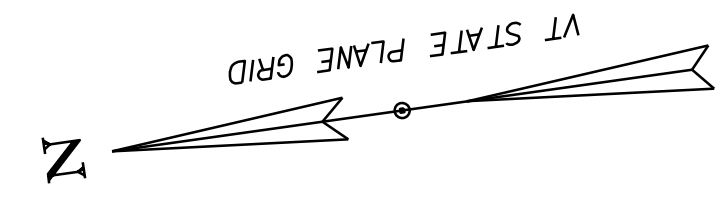
	5 FOOT OR GREATER SHOULDER WIDTH
	3 - 5 FOOT SHOULDER WIDTH
	LESS THAN 3 FOOT SHOULDER WIDTH

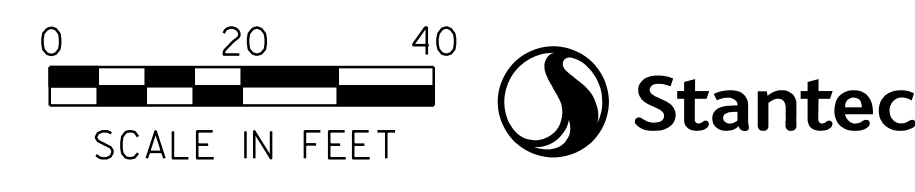

PROJECT NAME:	RICHMOND US-2 PINCH POINTS
PROJECT NUMBER:	179450619
FILE NAME:	Richmond US-2 Pinch Points.dgn
PLOT DATE:	4/20/2023
PROJECT LEADER:	M. FOWLER
DRAWN BY:	J. LAPERLE
DESIGNED BY:	J. LAPERLE
CHECKED BY:	M. FOWLER
PLAN SHEET	8 OF 12

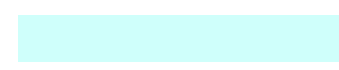

SHOULDER WIDTH COLOR KEY	
	5 FOOT OR GREATER SHOULDER WIDTH
	3 - 5 FOOT SHOULDER WIDTH
	LESS THAN 3 FOOT SHOULDER WIDTH

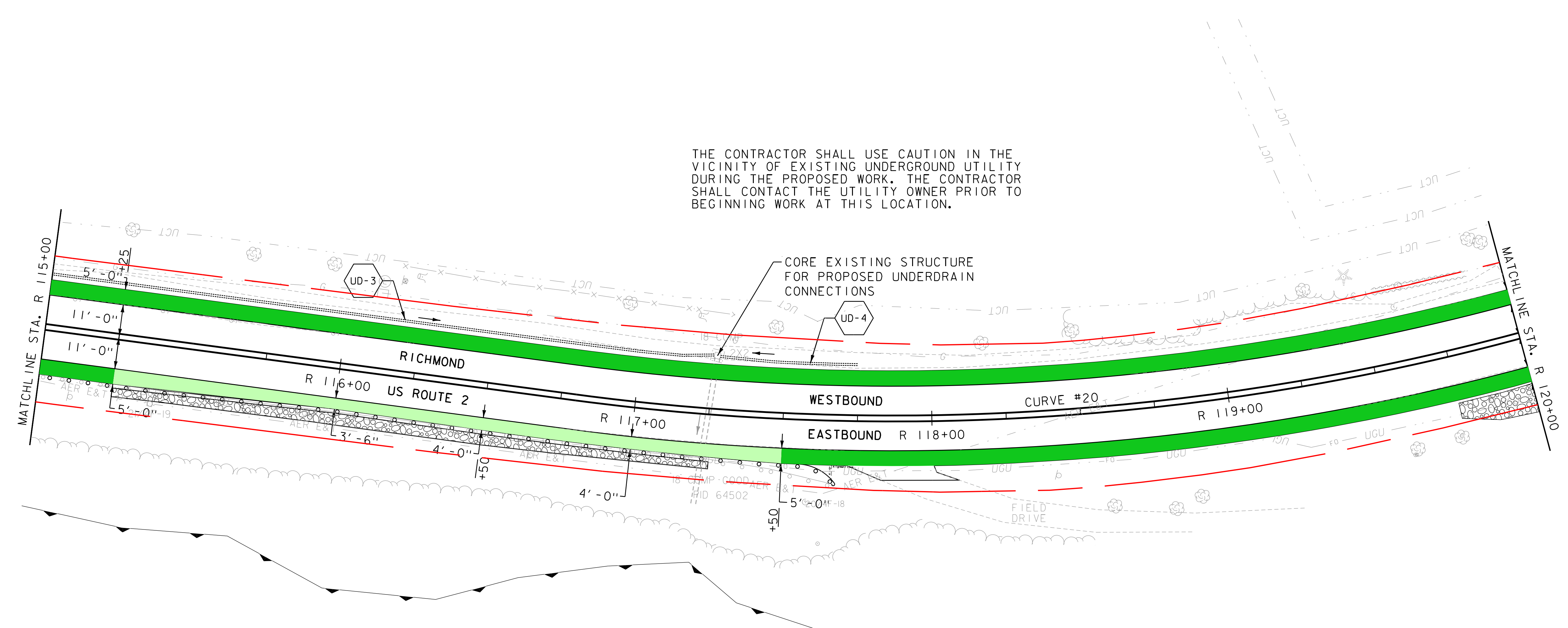
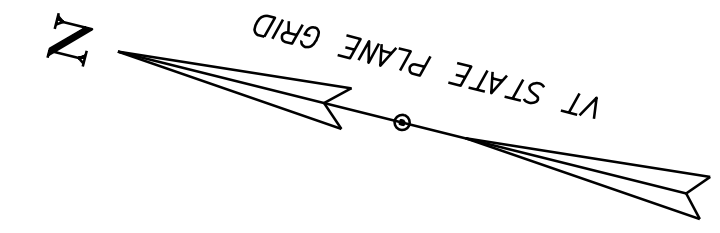



THE CONTRACTOR SHALL USE CAUTION IN THE VICINITY OF EXISTING UNDERGROUND UTILITY DURING THE PROPOSED WORK. THE CONTRACTOR SHALL CONTACT THE UTILITY OWNER PRIOR TO BEGINNING WORK AT THIS LOCATION.

CORE EXISTING STRUCTURE FOR PROPOSED UNDERDRAIN CONNECTIONS



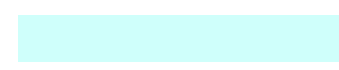

PROJECT NAME:	RICHMOND US-2 PINCH POINTS
PROJECT NUMBER:	179450619
FILE NAME:	Richmond US-2 Pinch Points.dgn
PLOT DATE:	4/20/2023
PROJECT LEADER:	M. FOWLER
DRAWN BY:	J. LAPERLE
DESIGNED BY:	J. LAPERLE
CHECKED BY:	M. FOWLER
PLAN SHEET	9 OF 12

SHOULDER WIDTH COLOR KEY

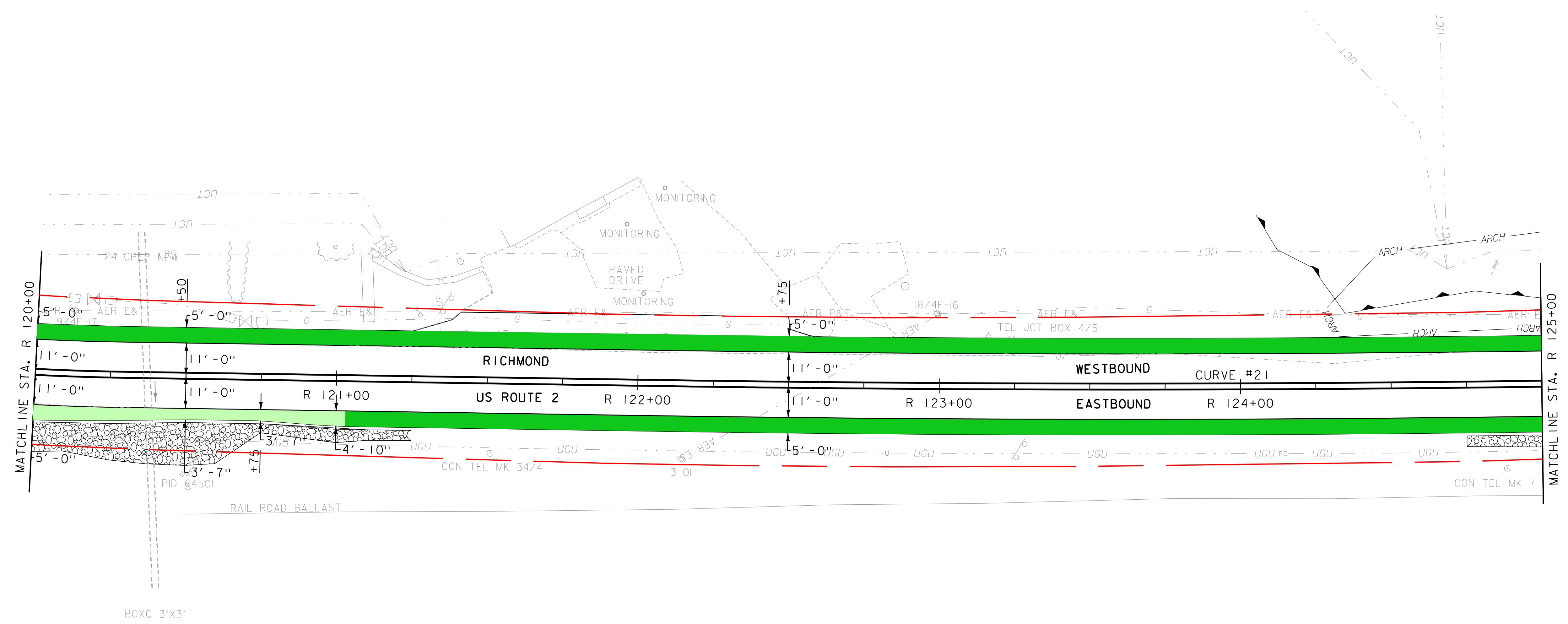
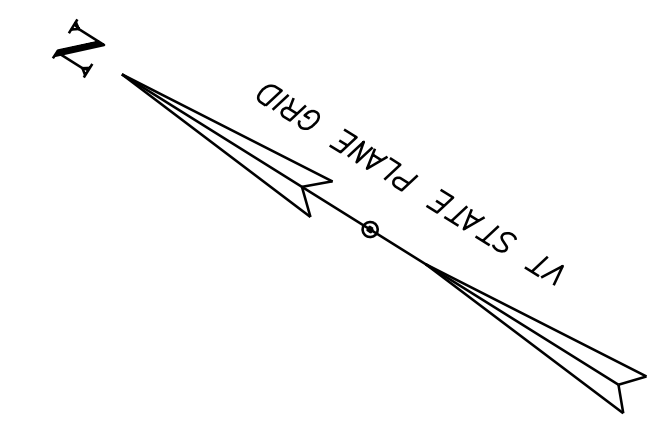
	5 FOOT OR GREATER SHOULDER WIDTH
	3 - 5 FOOT SHOULDER WIDTH
	LESS THAN 3 FOOT SHOULDER WIDTH

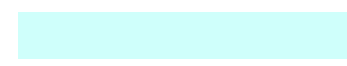

PROJECT NAME: RICHMOND US-2 PINCH POINTS	
PROJECT NUMBER: 179450619	
FILE NAME: Richmond US-2 Pinch Points.dgn	PLOT DATE: 4/20/2023
PROJECT LEADER: M. FOWLER	DRAWN BY: J. LAPERLE
DESIGNED BY: J. LAPERLE	CHECKED BY: M. FOWLER
PLAN SHEET 10	SHEET 10 OF 12

SHOULDER WIDTH COLOR KEY	
	5 FOOT OR GREATER SHOULDER WIDTH
	3 - 5 FOOT SHOULDER WIDTH
	LESS THAN 3 FOOT SHOULDER WIDTH

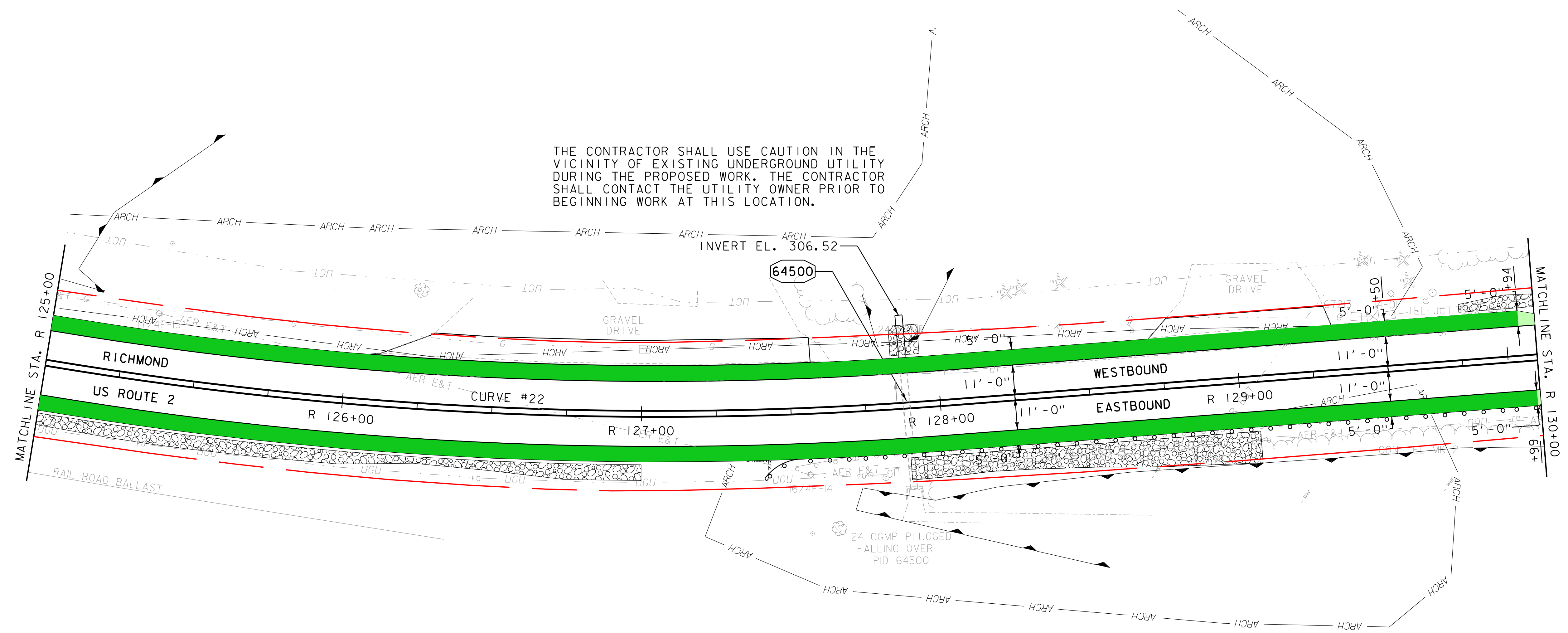
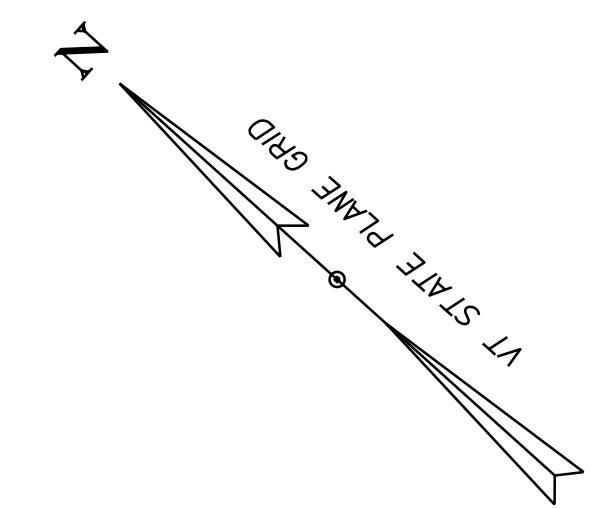

THE CONTRACTOR SHALL USE CAUTION IN THE VICINITY OF EXISTING UNDERGROUND UTILITY DURING THE PROPOSED WORK. THE CONTRACTOR SHALL CONTACT THE UTILITY OWNER PRIOR TO BEGINNING WORK AT THIS LOCATION.

INVERT EL. 306.52

64500

MATCHLINE STA. R 125+00

MATCHLINE STA. R 130+00

RICHMOND
US ROUTE 2

WESTBOUND
EASTBOUND

R 126+00

R 127+00

R 128+00

R 129+00

RAIL ROAD BALLAST



CURVE #22

24 CGMP PLUGGED
FALLING OVER
PID 64500

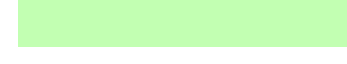

PROJECT NAME:	RICHMOND US-2 PINCH POINTS
PROJECT NUMBER:	179450619
FILE NAME:	Richmond US-2 Pinch Points.dgn
PLOT DATE:	4/20/2023
PROJECT LEADER:	M. FOWLER
DRAWN BY:	J. LAPERLE
DESIGNED BY:	J. LAPERLE
CHECKED BY:	M. FOWLER
PLAN SHEET II	SHEET II OF 12

SHOULDER WIDTH COLOR KEY

	5 FOOT OR GREATER SHOULDER WIDTH
	3 - 5 FOOT SHOULDER WIDTH
	LESS THAN 3 FOOT SHOULDER WIDTH

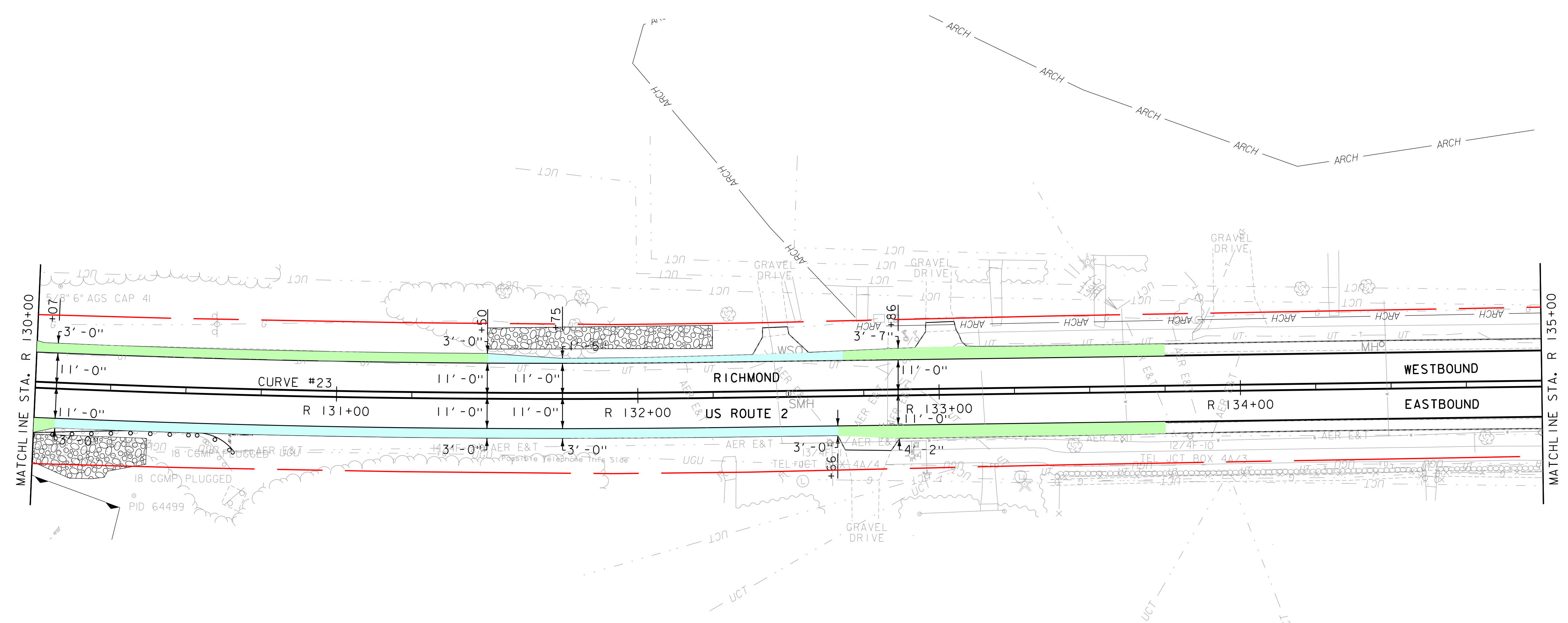
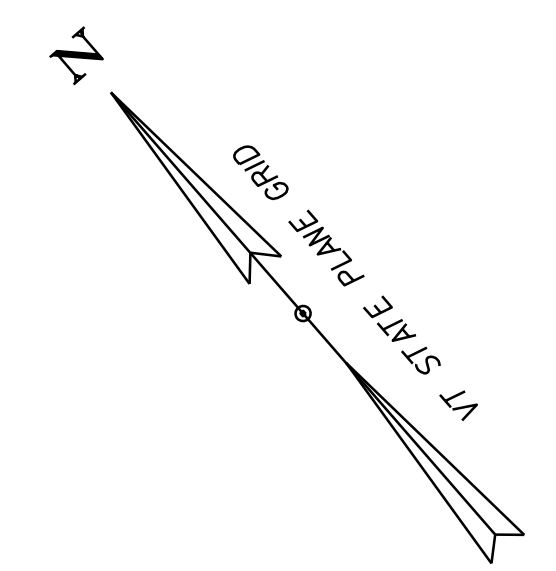

PROJECT NAME: RICHMOND US-2 PINCH POINTS	
PROJECT NUMBER: 179450619	
FILE NAME: Richmond US-2 Pinch Points.dgn	PLOT DATE: 4/20/2023
PROJECT LEADER: M. FOWLER	DRAWN BY: J. LAPERLE
DESIGNED BY: J. LAPERLE	CHECKED BY: M. FOWLER
PLAN SHEET 12	SHEET 12 OF 12