

VCPG LED Parking Garage



Catalog Number

Notes

Type

**22037W RICHMOND #2
Type SC (Solar Canopy)**

Hit the tab key or mouse over the page to see all interactive elements.

Specifications

Diameter: 19"

Height: 3.75"
(4.85" with Up-Light)

Weight 18 lbs
(max, with no options):

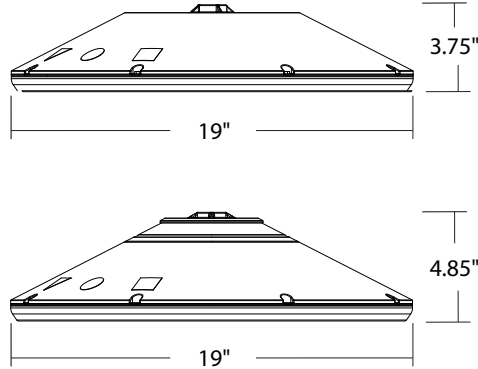

A+ Capable options indicated by this color background.

Introduction

The all new VCPG LED (Visually Comfortable Parking Garage) luminaire is designed to bring glare control, optical performance and energy savings into one package. The recessed lens design of VCPG LED minimizes high angle glare, while its precision molded acrylic lens eliminates LED pixilation and delivers the required minimums, verticals and uniformity. The dedicated up-light module option reduces the contrast between the luminaire and the ceiling creating a more visually comfortable environment.

The VCPG LED delivers up to 87% in energy savings when replacing 175W metal halide luminaires. With over 100,000 hour life expectancy (12+ years of 24/7 continuous operation), the VCPG LED luminaire provides significant maintenance savings over traditional luminaires.

Ordering Information

EXAMPLE: VCPG LED V4 P4 40K 70CRI T5M MVOLT SRM DNAXD

VCPG LED							
Series	LED Light Engines	Package	Color temperature	Color Rendering Index	Distribution	Voltage	Mounting
VCPG LED	V4 ¹ 4 Light Engines	P1 ¹	30K 3000 K	70CRI	T5M Type V, medium	MVOLT	For ordering with fuse Shipped included PM Pendant mount standard (24-inch length supply leads) SRM Surface mount (24-inch length supply leads) ARM Arm mount (use RSXWBA accessory to mount to a wall) Shipped separately YK Yoke/trunnion mount ³
		P2 ¹	35K 3500 K	80CRI	T5R ² Type V, rectangular	347 120	
	P3 ¹	40K 4000 K		T5W Type V, wide	480 208		
	P4 ¹	50K 5000 K		T5E Type V entry	240 240		
	P5 ¹			LANE ² Drive lane	277 277		
	P6 ¹				347 347		
	P7 ¹				480 480		

Options		Finish (required)	Packaging
Shipped installed UPL1 Up-Light: 500 lumens UPL2 Up-Light: 700 lumens E8WC Emergency battery backup, Certified in CA Title 20 MAEDBS (8W, -20°C min) ^{4,5,6} E10WH Emergency battery backup, Certified in CA Title 20 MAEDBS (10W, 5°C min) ^{4,5,6} HA High ambient (50°C, only P1-P4) SF Single fuse (120V, 277V, 347V) DF Double fuse (208V, 240V, 480V) SPD10KV 10KV Surge Pack LDS36 36in (3ft) lead length LDS72 72in (6ft) lead length LDS108 108in (9ft) lead length DMG External 0-10V leads (no controls) ⁷ TP Tamper proof screws Shipped Separately WG Wire Guard BDS Bird Shroud HS House Side Shield BSW Bird Spikes		DWHXD White DNAXD Natural aluminum DDBXD Dark bronze DBLXD Black FINISH SELECTED BY CONTRACTOR	(blank) Job Pack/Units (ships as job pack of 18pcs per; balance in units) U Unit packs only
Standalone Sensors/Controls² PIR Motion/ambient sensor for 8-15' mounting heights PIRH Motion/ambient sensor for 15-30' mounting heights PIR3FC3V Motion/ambient sensor for 8-15' mounting heights, pre programmed to 3fc and 35% light output PIRH3FC3V Motion/ambient sensor for 15-30' mounting heights, pre programmed to 3fc and 35% light output Networked Sensors/Controls² NLTAIR2 PIR nLIGHT AIR Wireless enabled motion/ambient sensor for 8-15' mounting heights NLTAIR2 PIRH nLIGHT AIR Wireless enabled motion/ambient sensor for 15-30' mounting heights NLTAIR2 PIR924 nLIGHT AIR Wireless enabled, UL924 Listed motion/ambient sensor for 8-15' mounting heights ⁸ NLTAIR2 PIRH924 nLIGHT AIR Wireless enabled, UL924 Listed motion/ambient sensor for 15-30' mounting heights ⁸			



Ordering Information Cont.

Accessories

Ordered and shipped separately.

VCPGBDS DWHXD U	Bird shroud for PM (specify finish)	VCPGWG U	Wire guard
VCPGBDS YK DWHXD U	Bird shroud for YK (specify finish)	SLVSQ	Quick mount pendant swivel kit, square
VCPGUBDS DWHXD U	Bird shroud for PM with Up-Light (specify finish)	SLVRD	Quick mount pendant swivel kit, round
VCPGUBDS YK DWHXD U	Bird shroud for YK with Up-Light (specify finish)	VCPG YK DWHXD U	Yoke mount kit (specify finish)
VCPGSRM U	Surface mount kit, with no Up-Light	RSXWBA DWHXD U	RSX WBA wall bracket (specify finish)
VCPGUSRM U	Surface mount kit, with Up-Light	VCPGHS DWHXD U	House side shield (specify finish)
VCPGSC120	Safety cable 120"		

NOTES

- P1-P6 not available with V8. P7 not available with V4.
- Not available with P7.
- Only vertical height adjustment. No angle adjustment. Use PM and SLVSQ or SLVRD for mounting to angled ceiling or canopies.
- Not available with 347V or 480V.
- E8WC and E10WH only rated up to 35°C ambient.
- E8WC & E10WH only available with P1-P4 packages.
- DMG option not available with standalone or networked sensors/controls.
- Needs an nLight Air Normal Power Sensing (NPS) device in the group. VCPG NLTAIR2 PIR and PIRH devices cannot act as NPS devices.

Performance Data

Lumen Output

Lumen values are from photometric tests performed in accordance with IESNA LM-79-08. Data is considered to be representative of the configurations shown, within the tolerances allowed by Lighting Facts. Contact factory for performance data on any configurations not shown here.

Performance Package	Watts	Distribution Type	30K (3000K, 70 CRI)		35K (3500K, 70 CRI)		40K (4000K, 70 CRI)		50K (5000K, 70 CRI)	
			Lumens	LPW	Lumens	LPW	Lumens	LPW	Lumens	LPW
P1	27W	TSE	3,581	135	3,670	138	3,815	144	3,876	146
		TSM	3,620	136	3,710	140	3,856	145	3,917	147
		TSW	3,592	135	3,681	139	3,827	144	3,888	146
		TSR	3,464	130	3,550	134	3,690	139	3,749	141
		LANE	3,507	132	3,594	135	3,736	141	3,796	143
P2	34W	TSE	4,577	135	4,691	138	4,876	144	4,954	146
		TSM	4,626	136	4,741	140	4,928	145	5,007	147
		TSW	4,591	135	4,705	139	4,891	144	4,968	146
		TSR	4,427	130	4,537	134	4,716	139	4,791	141
		LANE	4,482	132	4,594	135	4,775	141	4,851	143
P3	43W	TSE	5,808	134	5,952	137	6,187	143	6,286	145
		TSM	5,870	135	6,015	139	6,253	144	6,353	146
		TSW	5,825	134	5,970	138	6,205	143	6,304	145
		TSR	5,617	130	5,757	133	5,984	138	6,079	140
		LANE	5,688	131	5,829	134	6,059	140	6,155	142
P4	56W	TSE	7,391	131	7,575	135	7,874	140	7,999	142
		TSM	7,470	133	7,656	136	7,958	141	8,085	144
		TSW	7,414	132	7,597	135	7,898	140	8,023	143
		TSR	7,149	127	7,326	130	7,615	135	7,737	137
		LANE	7,238	129	7,418	132	7,711	137	7,834	139
P5	82W	TSE	10,189	124	10,442	127	10,854	132	11,027	134
		TSM	10,298	125	10,553	128	10,970	134	11,145	136
		TSW	10,220	124	10,473	128	10,887	133	11,060	135
		TSR	9,855	120	10,099	123	10,498	128	10,665	130
		LANE	9,978	121	10,226	124	10,629	129	10,799	131
P6	108W	TSE	12,878	120	13,197	123	13,719	127	13,937	129
		TSM	13,015	121	13,338	124	13,865	129	14,086	131
		TSW	12,917	120	13,237	123	13,760	128	13,979	130
		TSR	12,455	116	12,764	119	13,268	123	13,480	125
		LANE	12,611	117	12,924	120	13,435	125	13,649	127
P7	122W	TSE	15,503	125	15,887	128	16,515	133	16,778	135
		TSM	15,668	126	16,057	129	16,691	135	16,957	137
		TSW	15,549	125	15,935	129	16,564	134	16,828	136

Up-light Lumen Output

Up-light Option	Watts	Lumens
UPL1	6.5W	519
UPL2	8.5W	715

Lumen Multiplier for 80CRI

CCT	Multiplier
30K	0.926
35K	0.945
40K	0.967
50K	0.965

Lumen Ambient Temperature (LAT) Multipliers

Use these factors to determine relative lumen output for average ambient temperatures from 0-40°C (32-104°F).

Ambient	Lumen Multiplier
0°C / 32°F	1.03
10°C / 50°F	1.02
20°C / 68°F	1.01
25°C / 77°F	1
30°C / 86°F	0.99
40°C / 104°F	0.98

Projected LED Lumen Maintenance

Data references the extrapolated performance projections for the platforms noted in a 25°C ambient, based on 10,000 hours of LED testing (tested per IESNA LM-80-08 and projected per IESNA TM-21-11).

To calculate LLF, use the lumen maintenance factor that corresponds to the desired number of operating hours below. For other lumen maintenance values, contact factory.

Operating Hours	0	25,000	50,000	100,000
Lumen Maintenance Factor	1.0	0.97	0.94	0.89

Electrical Load

Power Package	System Watts	Current (A)					
		120V	208V	240V	277V	347V	480V
P1	27W	0.22	0.13	0.12	0.10	0.08	0.06
P2	34W	0.28	0.16	0.14	0.13	0.10	0.08
P3	43W	0.37	0.21	0.18	0.16	0.13	0.09
P4	56W	0.48	0.28	0.24	0.21	0.16	0.12
P5	82W	0.68	0.40	0.35	0.30	0.24	0.18
P6	108W	0.91	0.52	0.45	0.39	0.32	0.23
P7	124W	1.03	0.59	0.51	0.44	0.37	0.27



Photometric Diagrams

To see complete photometric reports or download .ies files for this product, visit the [Lithonia Lighting VCPG LED homepage](#).
Tested in accordance with IESNA LM-79 and LM-80 standards

VCPG LED P4 TSM 40K

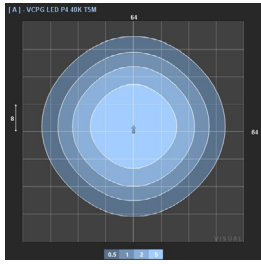

VCPG LED P4 T5E 40K

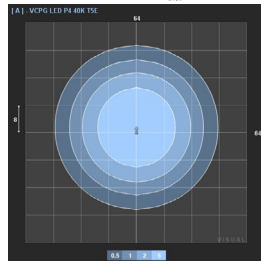

VCPG LED P4 T5W 40K

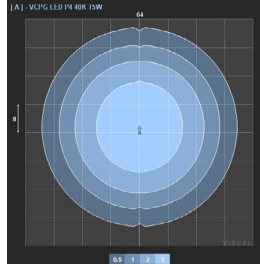

VCPG LED P4 T5R 40K

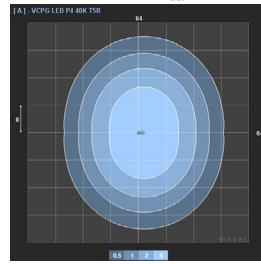

VCPG LED P4 LANE 40K

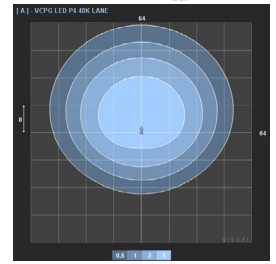

Control/Sensor Options

Motion/Ambient Sensor (PIR, PIRH)

Motion/Ambient sensor (Sensor Switch MSOD) is integrated into the luminaire. The sensor provides both Motion and Daylight based dimming of the luminaire. For motion detection, the sensor utilizes 100% Digital Passive Infrared (PIR) technology that is tuned for walking size motion while preventing false tripping from the environment. The integrated photocell enables additional energy savings during daytime periods when there is sufficient daylight. Optimize sensor coverage by either selecting PIR or PIRH option. PIR option comes with a sensor lens that is optimized to provide maximum coverage for mounting heights between 8-15ft, while PIRH is optimized for 15-40ft mounting height.

Networked Control (NLTAIR2)

nLight® AIR is a wireless lighting controls platform that allows for seamless integration of both indoor and outdoor luminaires. Five-tier security architecture, 900 MHz wireless communication and app (CLAIRITY™ Pro) based configurability combined together make nLight® AIR a secure, reliable and easy to use platform.

PIR HIGH VIEW

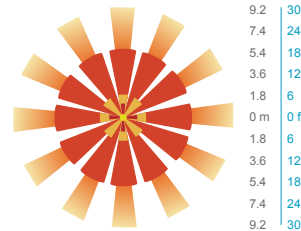
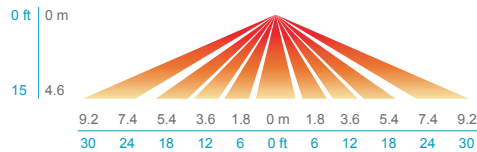

PIRH

SIDE VIEW

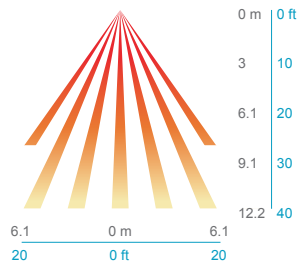

TOP VIEW

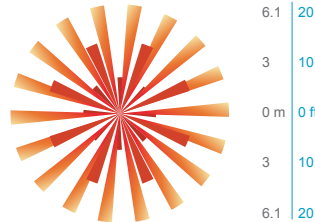

Motion/Ambient Sensor Default Settings

Option	Dim Level	High Level (when triggered)	Photocell Operation	Motion Time Delay	Ramp-down Time	Ramp-up Time
PIR or PIRH	Motion - 3V (37% of full output) Photocell - 0V (turned off)	10V (100% output)	Enabled @ 5fc	5 min	5 min	Motion - 3 sec Photocell - 45 sec
PIR3FC3V or PIRH3FC3V	Motion - 3V (37% of full output) Photocell - 0V (turned off)	10V (100% output)	Enabled @ 3fc	5 min	5 min	Motion - 3 sec Photocell - 45 sec

Mounting, Options & Accessories



PM – Pendant Mount
(compatible with 3/4 NPT,
pendant stem provided by
others)
D = 19"
H = 4.1"



SRM – Surface Mount
D = 19"
H = 4.1"



**SRM – Surface Mount
with Up-Light**
D = 19"
H = 5.3"



YK – Yoke/Trunnion Mount
D = 19"
H (Yoke) = 10"-18"



ARM – Arm Mount
L = 28"
W = 19"
H = 8"



**PIR & PIRH – Motion/
Ambient sensor**
D = 19"
H = 4.6" or
+1" (with up-light)
+2" (with nLight AIR)

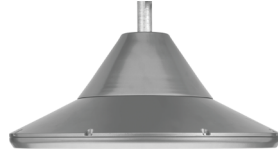

**BDS – Bird shroud for
pendant mount**
D = 19"
H = 8"



**BDS – Bird shroud for
yoke mount**
D = 19"
H (Yoke) = 10"-18"

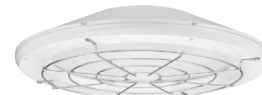

WG – Wire guard
D = 19"
H = 4.9" (no up-light) or
5.9" (with up-light)



HS – House side shield
D = 19"
H = 7.1" (no up-light) or
8.1" (with up-light)

FEATURES & SPECIFICATIONS

INTENDED USE

The visually comfortable optics, energy savings, and long life of the VCPG LED Parking Garage luminaire make it an ideal choice for new commercial installations and retrofit parking garage opportunities. It is designed to meet or exceed recommended illuminance criteria when installed as a direct replacement of most HID parking garage luminaires. Its modern dayform and aesthetics also make it appealing for indoor low-bay applications.

CONSTRUCTION

Two-piece die-cast aluminum housing has integral heat sink fins to optimize thermal management through conductive and convective cooling. The LED driver is separated from the heat generating light engines and mounted in direct contact with the casting to promote low operating temperatures, higher lumen maintenance and long life. The housing is completely sealed against moisture and environmental contaminants (IP66) and is suitable for hose-down application.

FINISH

Exterior painted parts are protected by a zinc-infused Super Durable TGIC thermoset powder coat finish that provides superior resistance to corrosion and weathering. A tightly controlled multi-stage process ensures a 3 mils thickness for a finish that can withstand extreme climate changes without cracking or peeling.

OPTICS

Light guide technology provides a diffused light source, reducing glare from direct view of the LEDs. The light source is recessed into the luminaire, further reducing the high angle glare from the luminaire. A combination of precision molded micro prismatic acrylic lenses and back reflectors provide five different photometric distributions tailored specifically to parking garage applications. Up-light option comes with a dedicated light engine and custom optic designed to efficiently spread light on to the ceiling, thus reducing the cave effect.

ELECTRICAL

Light engine consists of high-efficacy LEDs mounted to metal-core circuit boards to maximize heat dissipation and promote long life (up to L89/100,000 hours at 25°C). The electronic driver has a power factor of >90%, THD <20%, and a minimum 6.0 KV surge rating. When ordering the SPD10KV option, a separate 10kV (5kA) surge protection device is installed within the luminaire which meets a minimum Category C low operation (per ANSI/IEEE C62.41.2). Luminaire is 0-10V dimmable down to 10% or lower.

INSTALLATION

Standard configuration accepts a rigid or free-swinging 3/4" NPT stem for pendant mounting. The surface mount option attaches to a 4x4" recessed or surface mount outlet box using a quick-mount kit (included); kit contains galvanized steel luminaire and outlet box plates and a full pad gasket. Kit has an integral mounting support that allows the luminaire to hinge down for easy electrical connections. Luminaire and plates are secured with set screws. Also, available with a yoke/trunnion mount option with 3/4" NPT provision for flexible conduit entry (conduit by others); height can be adjusted from 10-18". Supply leads are 24" in length as standard. Longer supply leads are available as additional options. Design can withstand up to a 3.0 G vibration load rating per ANSI C136.31.

LISTINGS

CSA certified to U.S. and Canadian standards. IP66 rated for outdoor applications. PIR options are rated for wet location. Rated for -40°C minimum ambient. DesignLights Consortium® (DLC) Premium qualified product and DLC qualified product. Not all versions of this product may be DLC Premium qualified or DLC qualified. Please check the DLC Qualified Products List at www.designlights.org/QPL to confirm which versions are qualified.

BUY AMERICAN ACT

This product is assembled in the USA and meets the Buy America(n) government procurement requirements under FAR, DFARS and DOT regulations. Please refer to www.acuitybrands.com/resources/buy-american for additional information.

WARRANTY

5-year limited warranty. This is the only warranty provided and no other statements in this specification sheet create any warranty of any kind. All other express and implied warranties are disclaimed. Complete warranty terms located at: www.acuitybrands.com/support/warranty/terms-and-conditions

Note: Actual performance may differ as a result of end-user environment and application.

All values are design or typical values, measured under laboratory conditions at 25 °C. Specifications subject to change without notice.

